

**LUDLUM MODELS
702i and 711i
ISOTOPE IDENTIFIERS**

September 2021

**Serial Number ID001000 and Succeeding
Serial Numbers**

**LUDLUM MODELS
702i and 711i
ISOTOPE IDENTIFIERS
September 2021
Serial Number ID001000 and Succeeding
Serial Numbers**



LUDLUM MEASUREMENTS, INC
501 OAK STREET, P.O. BOX 810
SWEETWATER, TEXAS 79556
325-235-5494, FAX: 325-235-4672



Model 702i Isotope Identifier

STATEMENT OF WARRANTY

Ludlum Measurements, Inc. warrants the products covered in this manual to be free of defects due to workmanship, material, and design for a period of twelve months from the date of delivery. The calibration of a product is warranted to be within its specified accuracy limits at the time of shipment. In the event of instrument failure, notify Ludlum Measurements to determine if repair, recalibration, or replacement is required.

This warranty excludes the replacement of photomultiplier tubes, G-M and proportional tubes, and scintillation crystals which are broken due to excessive physical abuse or used for purposes other than intended.

There are no warranties, express or implied, including without limitation any implied warranty of merchantability or fitness, which extend beyond the description of the face there of. If the product does not perform as warranted herein, purchaser's sole remedy shall be repair or replacement, at the option of Ludlum Measurements. In no event will Ludlum Measurements be liable for damages, lost revenue, lost wages, or any other incidental or consequential damages, arising from the purchase, use, or inability to use product.

RETURN OF GOODS TO MANUFACTURER

If equipment needs to be returned to Ludlum Measurements, Inc. for repair or calibration, please send to the address below. All shipments should include documentation containing return shipping address, customer name, telephone number, description of service requested, and all other necessary information. Your cooperation will expedite the return of your equipment.

**LUDLUM MEASUREMENTS, INC.
ATTN: REPAIR DEPARTMENT
501 OAK STREET
SWEETWATER, TX 79556**

**800-622-0828 325-235-5494
FAX 325-235-4672**

REVISION HISTORY			
REV	DESCRIPTION	DATE	BY
1	VALID	6/22/2011	DDW
2	SEE ECF 2,594	9/21/2012	DDW
3	SEE ECF 2,792	4/17/14	DDW
4	SEE ECF 2,651	11/21/14	DDW
5	ECF #4912	10/31/17	WJM

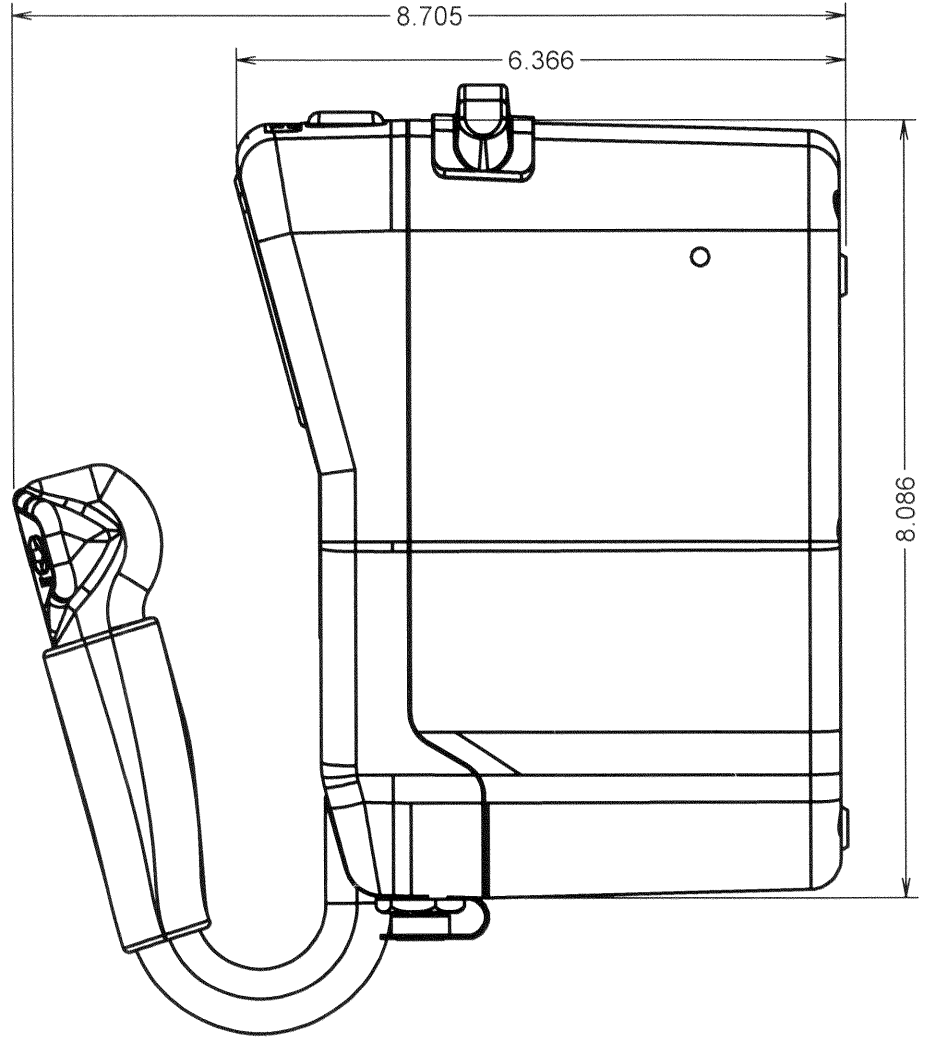
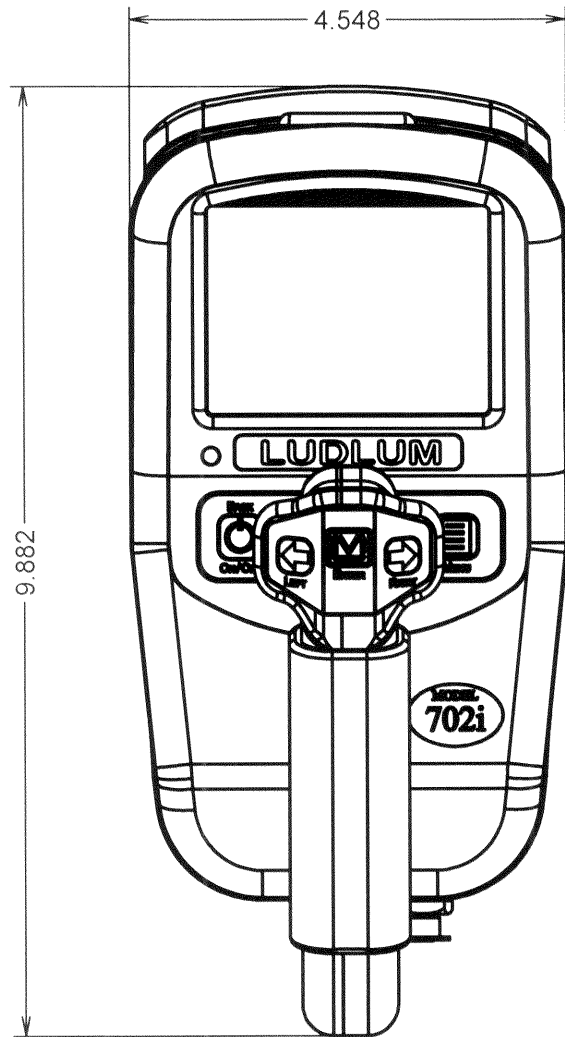

DWN	DATE	CHK	DATE	APP	DATE
WJM	10/31/17			WJM	10-31-17
DWG NUM: 4533-019				SCALE: 1/2	
TITLE M 702i W/O ACCESSORIES					
 LUDLUM MEASUREMENTS, INC. 501 OAK STREET SWEETWATER, TEXAS 79556		SERIES 533	SHEET 19		

REVISION HISTORY			
REV	DESCRIPTION	DATE	BY
1	VALID	6/22/2011	DDW
2	SEE ECF 2,594	9/21/2012	DDW
3	SEE ECF 2,792	4/17/14	DDW
4	SEE ECF 2,651	11/21/14	DDW
5	ECF #4912	10/31/17	WJM

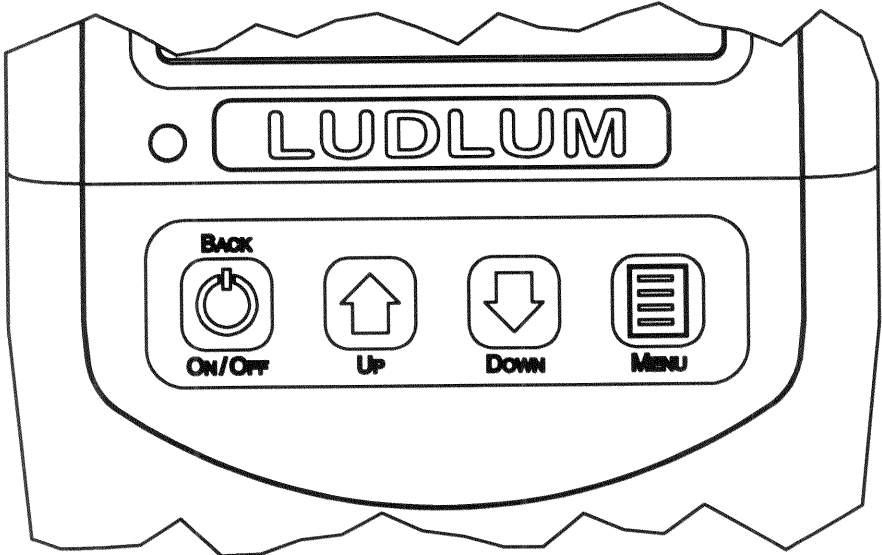

MAIN KEYPAD
SCALE 1 : 1

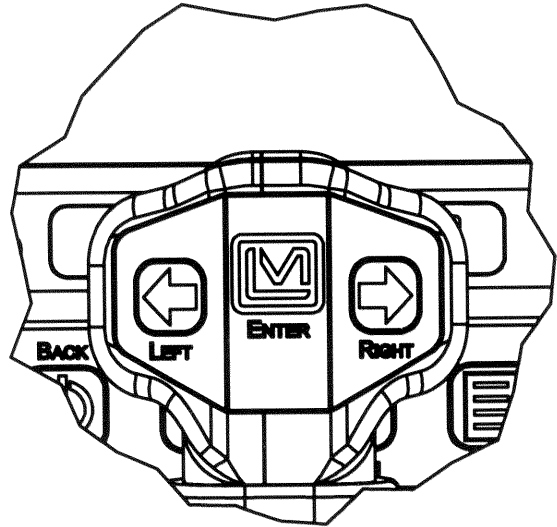

HANDLE KEYPAD
SCALE 1 : 1

DWN	DATE	CHK	DATE	APP	DATE
WJM	10/31/17			WJM	10-31-17
DWG NUM: 4533-019				SCALE: 1:1	
TITLE M 702i KEYPADS					
 LUDLUM MEASUREMENTS, INC. 501 OAK STREET SWEETWATER, TEXAS 79556			SERIES	SHEET	
			533	19A	

Table of Contents

<i>Introduction</i>	1
About your Model 702i/711i Unit	1-1
Caution Statement	1-1
<i>Getting Started</i>	2
Basic Operation	2-1
Menu	2-2
Description of Keypad and Soft Keys	2-2
Display Conventions	2-3
Self-Test and Data Screen	2-4
Choosing User or Administrator Operation	2-5
Software	2-6
<i>Connections</i>	3
Connecting AC Power or a Car Adaptor	3-1
CompactFlash Card	3-1
Batteries	3-2
Ethernet Connection for Data Output	3-3
<i>Specifications</i>	4
<i>Safety Considerations</i>	5
Cleaning Instructions and Precautions	5-1
Warning Markings and Symbols	5-1
<i>Recycling</i>	6
<i>General Operation</i>	7
Turning the Unit On and Off	7-1
Search Modes	7-1
Audible Search Setting	7-5
Taking a Background	7-5
Identifying Sources of Radiation	7-7
Analysis Report	7-8
Storing, Reviewing and Retrieving Spectra	7-9
<i>Manual Calibration</i>	8
Coarse Calibration	8-1
Dose Rate and Fine Energy Calibration	8-3

<i>System Menus</i>	9
Introduction	9-1
Run a Procedure/Display Information/Open Submenu	9-2
Check Option On or Off	9-2
Adjust Slider	9-2
Select Among Options	9-3
Isotope List	9-3
Edit Numeric Value	9-4
Edit Date for Filter	9-5
User Menus	9-5
Field Settings	9-5
Spectral Data	9-8
Configuration	9-10
Help Menu	9-11
Administrator Menus	9-12
Configuration (Extra Items)	9-12
Admin	9-13
Factory Settings	9-17

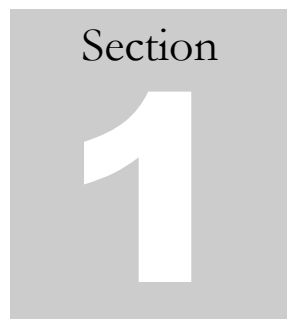

Introduction

About Your Model 702i/711i Unit

The Ludlum Model 702i and 711i units are portable radioisotope identification (RID) systems that detect and identify multiple nuclides, providing quantified results using time-slice analysis. Both batteries and the gamma detector are internal, allowing for a compact but sensitive isotope identification.

The 702i uses a NaI detector, while the 711i uses a LaBr detector. With the LaBr detector, the 711i provides an extremely high resolution for ^{137}Cs at 661 keV of 3.5 to 5%. This means a higher confidence level of isotope differentiation and identification.

The instruments can be operated either in a very simple mode requiring no previous experience or in other operating modes that take advantage of the comprehensive set of advanced features.

The Model 702i and 711i units offer two log-on modes: **User** and **Administrator**. The **User** functions allow first-line responders to perform all the tasks needed in the line of duty. The **Administrator** functions allow a health physicist, or other expert, to set up the device for specific applications and to perform additional maintenance functions. This manual will cover aspects of both, but places an emphasis on **User** functions.

CAUTION! It is important to limit access to Administration Mode to those who are qualified to use it. This mode includes the advanced functions of the instrument and allows the user access to everything. The general user should be limited to User Mode only. If any of the advanced functions are altered incorrectly, it could affect the overall function of the instrument and may require expensive re-calibration. Please see Section 2, starting with page 2-5, for details on how to set up the Administration Mode and protect the mode with a password.

Once you set a password for the Administration Mode, it is important not only to keep it private, but to not lose it or forget it. If the password is forgotten, it can only be reset by the factory.

In addition, do not alter calibration settings, or it may incorrectly alter the instrument's functions and require repair by the factory.

After logging on, the device powers up in an initial search mode. Several different views of this mode are available, but all are based on data collected in real time. In addition to the search modes, setup, alarm review, and calibration functions can be accessed through the menu system.

The instrument has a simple user interface and a wide range of setup functions and utilities.

The Model 702i or 711i unit can be connected to a remote computer using an Ethernet cable, and accessed with either Quantum™ MCA (standard) or Quantum™ Gold (quantitative analysis) software. The Quantum™ software (available upon request) allows:

Up to eight MCAs to be controlled at one time, with full spectrum data in real time.

Model 702i or 711i unit analysis in 256 QCC or linear, 512 QCC or linear, and 1024 linear modes.

Note that if you are using either the Model 702i or 711i unit without a PC, operation is limited to 256 and 512 QCC, including the saving of spectra. However, while under control of Quantum software, all ADC modes (including 1024 linear) are available.

The basic Model 702i or 711i unit consists of:

The spectrometer electronics

Internal gamma ray detector

An AC power adapter

Optional devices include:

Quantum software

A car power adapter

Section
2

Getting Started

Turn on the Model 702i or 711i unit by holding down the power key Φ (which is also the BACK key) until the status screen appears. Press ENTER to move to the log-in screen, and then press ENTER (\leftarrow) again to advance to the user-mode search screen (generally Dial). At the bottom of the screen there will be a message indicating auto calibration is in progress. This may take one to three minutes. The instrument is then ready for use.

Basic Operation

Refer to the following screen drawing, where three soft keys will be seen (**Identify**, **Background**, **Finder**). These are accessed by the LEFT (\leftarrow) or RIGHT (\rightarrow) arrow keys and then pressing ENTER. The far right soft key allows the user to select between the available search modes. The Dial and Finder screens are the simple modes of operation where the Dial gives count rate information in the form of a speedometer. When radioactive material gives an indication in the green region, this signals proper source intensity for identification with gamma count rate. The other colored regions indicate the source is too far (gray) or too close (red). The Finder mode allows location of the source by displaying intensity vertically and time horizontally. The midscale “ID” shows the proper intensity for identification. In addition, an audio signal can aid in finding the source. The other two search modes (Bars and Spectrum) are more advanced and must be enabled in the administrator menu. These two screens allow the user to view isotopes in the form of vertical “Bars” or a “Spectrum,” where the isotope is identified or its presence is seen in real time. These modes also give isotope category and dose rate in real time.

Identification may be performed in any one of the four modes. Simply highlight the **Identify** soft key and press ENTER. A report appears after the acquisition period. Isotopes identified are shown with a statistical confidence number ranging from 0 to 100%. This is based on source strength, length of acquisition, number of energy lines, and statistical factors. The default for taking a background or acquiring a spectrum is one minute. The length of acquisition can be increased or decreased by pressing ENTER when the soft key is on ± 30 seconds. If ENTER is held down, the length of time can be changed rapidly. Pressing the BACK key allows the user to return to the search modes. Holding down the BACK / power key for a count of three seconds turns the instrument off.

Menu

Coarse calibration, review of stored spectra, thresholds, and many other features can be accessed from the user or administrator (password protected) menu. The menu can be accessed from any one of the search modes.

Description of Keypad and Soft Keys

Figure 1 shows a rendering of the Model 702i keypads. Some of the keys are located underneath the display, while the most commonly used keys are located on the handle.



Figure 1 – Model 702i Keypad

The following is a brief description of the seven keys and how they are used.

- | | |
|---------|---|
| BACK/☺ | Returns to previous screen, exiting from menu or report. This key is also used to turn system power on and off. |
| MENU | Enters the menu system from any search screen. |
| ENTER | Used to select currently highlighted option, such as a soft key or a menu item and also used to continue to next step of multi-step processes. |
| ◀ and ▶ | These keys will be referred to throughout the text as LEFT and RIGHT. They are used to select among the soft-key options or menu tabs, to move backward and forward in a string entry process, to select among items in a menu choice process, and for various other applications that will be described later in the document. |
| ▲ and ▼ | These keys will be referred to as UP and DOWN. They are used to scroll among menu items, to scroll through reports, to change the current letter when entering a string such as a password, and for various other applications that will be described later in the document. |

Many of the common operations of the Model 702i or 711i are performed using “Soft Keys.” These are represented by a set of words in a gray bar shown at the bottom of the screen. In Figure 2, the normal soft keys seen in the “Dial” search screen are shown. The **Identify** soft key is currently selected. By pressing the LEFT and RIGHT keys, you can move the highlighting among the other soft keys, **Background** and **Finder**. Pressing the ENTER key will perform the action specified by the currently highlighted soft key, for example, entering the identification mode to collect, report, and store an analysis of a possible radioactive substance.

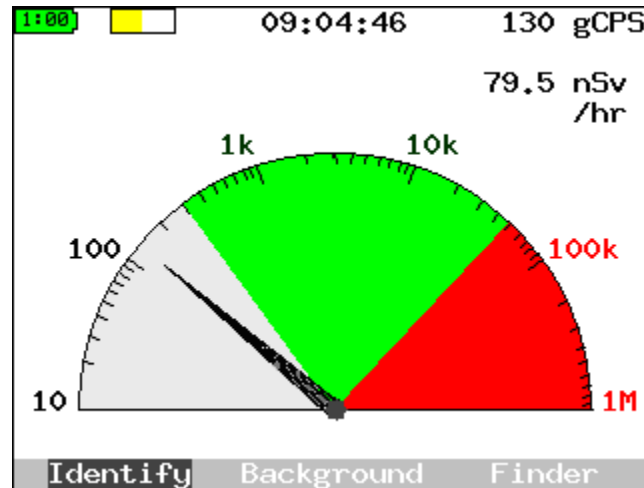

Figure 2 - Example of Soft Keys

Display Conventions

In order to make the Model 702i or 711i more friendly and easy to use, we have defined several color and layout conventions for the user interface.

Four different nuclide “classes” are defined by their colors, which appear as labels and as filled-in areas in spectra. Blue is for industrial (IND), magenta for special nuclear materials (SNM), cyan for medical (MED), and green for naturally occurring radioactive materials (NORM or NRM). In addition, when there is insufficient data to be sure something is present, it will be marked in yellow for uncertain (UNC). When there is something definitely present but not matched to any currently enabled nuclide, it will be labeled in red for unknown (UNK).



In other contexts, red is used to signal bad conditions (dead battery, calibration failure, dangerous dose rate); yellow and orange indicate concern (battery nearing end of life, calibration incomplete); and green indicates everything is normal (battery good, calibration done, OK to ID).

Soft keys are always displayed at the very bottom of the screen in shades of black and white.

In most cases, where possible, small arrows are shown on the currently selected item to indicate possible choices. For example, on a selected menu tab, you can go LEFT or RIGHT or DOWN into the menu. For some menu items, you may be able to use LEFT and RIGHT to change the value. Two examples are shown here.



Different colors are used to group the items in each of the main menus. All sub-menus (the menus that come up within an operation selected from the menu system) are displayed in shades of gray and white. The shading serves to remind you that if you exit from this menu with the BACK key, it will only take you back to the higher level menu.

Self-Test and Data Screen

When the Model 702i or 711i unit is first powered on, you will see a screen that shows the results of an initial power-on self test, or “POST.” A properly functioning unit will have a display similar to that shown in Figure 3. The internal case temperature may vary, and your estimated battery life will change as batteries are charged and discharged. Press ENTER to continue to the log-in screen.

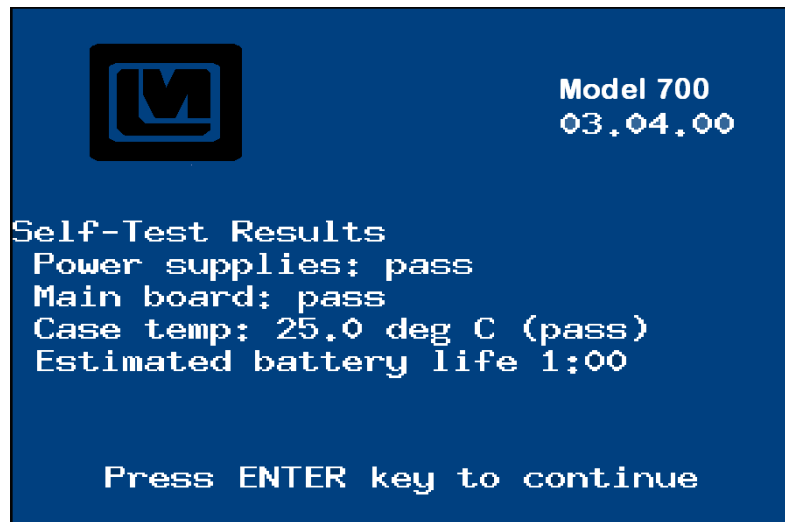

Figure 3 - Successful POST Screen

Choosing User or Administrator Operation

Immediately after the self-test screen, a log-in screen appears, as shown in Figure 4. On this screen you have the option of logging in as the **User** or **Administrator**. The **User** functions allow first-line responders to perform all the tasks needed in the line of duty. The **Administrator** functions allow a health physicist or other expert to set up the device for specific applications, and to perform additional maintenance functions.¹ The **User** mode can generally be accessed without a password, while the **Administrator** mode requires a password to be entered.

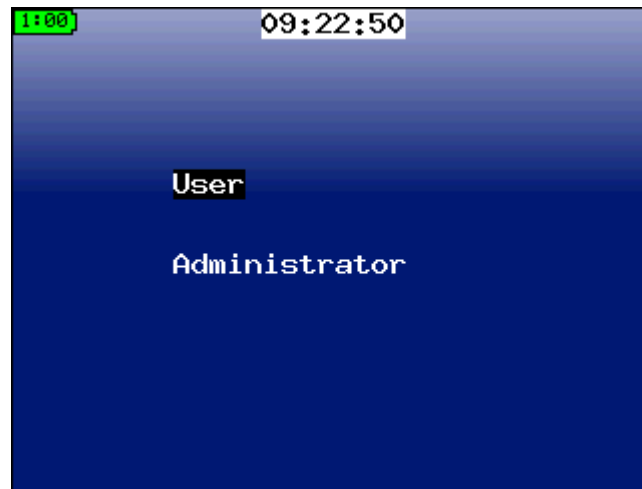

Figure 4 – Log-in Screen with User Selected



Figure 5 – Log-in Screen for Administrator with Password

¹ These modes are designed to comply with ANSI N42.34 *Routine* and *Restricted* modes and IAEA Pub 1240 *Easy* and *Expert* modes.

When entering a password, as shown for the **Administrator** in Figure 5, use the UP and DOWN arrows to change the letter, and the LEFT and RIGHT arrows to move within the word. Holding down the UP or DOWN arrows will rapidly scan through the alphabet. The word *is* is displayed on the screen, otherwise it would be impossible to determine what letter is being entered! To ensure confidentiality, enter the password while no one else can see the screen.

Software

The Quantum™ software (available upon request) is a useful tool for advanced users seeking additional analytical capabilities for their Model 702i and 711i spectra. The Quantum software is supplied in two basic configurations, Quantum MCA and Quantum Gold.

Quantum MCA, a subset of Quantum Gold, is the "standard" software and provides qualitative, but not quantitative analysis. Qualitative analysis will allow analyzing for the type of isotope present, but not how much of each isotope is present. Certain features, such as background subtraction, are considered part of the quantitative analysis package and are not available in Quantum MCA.

Quantum Gold supports both quantitative and qualitative analysis, and is the software the Quantum software manual is written for.

A graphic for Section 3 Connections. It features a grey square on the left containing the word "Section" in a small font above a large white number "3". To the right of this square, the word "Connections" is written in a large, bold, black sans-serif font. A horizontal line is positioned below the word "Connections".

Section 3 Connections

The Model 702i and 711i units have two external connectors for power, communications, and other functions. In the back right-hand corner is a watertight connector that provides AC power. There is a flexible, rubber port cover at the top front, and behind it are a CompactFlash slot on the left and an Ethernet connector on the right.

Connecting AC Power or a Car Adaptor

A universal (110-240 V, 50/60 Hz) AC power supply is supplied for your unit. This power supply will run the unit and charge the internal batteries, and connects directly to the watertight connector. The other model requires an adapter cable, which plugs into the watertight connector. Then the AC power supply plugs into a mating plug on the adapter cable.

The car adaptor plugs into a 12-volt accessory outlet or “cigarette lighter” outlet in your vehicle. It then connects to the watertight connector on the unit.

CompactFlash Card

Your unit comes with a CompactFlash card that serves the following purposes:

- Storage for a nearly unlimited number of spectra in ANSI standard (N42.42) format.
- Storage of specific system configuration information.
- Easily upgradeable system firmware.

Do not remove the CompactFlash card while the system is turned on. The system will not continue to operate without the card in place. It is best to turn the unit off, remove the card, perform whatever activities are needed, and reinsert the card before turning the unit back on. Also, it is important to note that this card is ***specific to your unit and detector***. In fact, the serial number of the electronics and detector is printed on your particular CompactFlash card. Because each unit is factory calibrated for optimal performance, and this calibration is stored on the CompactFlash card, the cards should never be exchanged between different units. Also, the contents of the card should not be erased, except through the menus provided in the unit itself.

You may wish to read the saved spectral information on the card using your PC. If your PC includes a media reader bay, you should be able to insert the card and read it as simply as you would access a CD-ROM or floppy. If your PC does not have a media reader built in, a simple USB flash card reader can be easily purchased from a commercial supplier. In either case, the device will be assigned a drive letter, often E: or F: (we will assume E: throughout this document). The spectra may then be read from the directory E:\spectra.

Batteries

Your Model 702i and 711i unit comes equipped with eight internal rechargeable AA batteries. These batteries are normally charged by plugging in the external charger. Access to the battery compartment requires removal of the lower enclosure.

Depending on usage, the Model 702i and 711i unit will generally run six to eight hours on a single charge when the recommended batteries are used. There are several ways to improve your battery life:

- Reduce the display brightness as low as possible without affecting your ability to read the display. If operating out-of-doors, you may find that the reflected sunlight is sufficient to read the display even with the brightness at its minimum setting.

- Turn off the *Audible Count Rate* and/or *Mute* the speaker.

- Shorten the *Backlight Timeout* so the display darkens when you are not using the system.

- Use AC power when connecting to a PC or doing other stationary operations in the office. The unit will automatically run from AC power if it is available.

Ethernet Connection for Data Output

In addition to accessing data directly on the CompactFlash card, the Ethernet connector can be used to connect your unit to a building network or to your PC. By making this connection, you will be able to access data on the unit, including operating it remotely with the Quantum™ software (available upon request).

If you are connecting to an Ethernet switch or hub, a standard CAT-5 Ethernet cable can be used. If you wish to connect directly to your PC, you will need a special “crossover” cable that takes the place of the switch or hub. Both of these are available as accessories.

Connect the Model 702i or 711i unit to the local Ethernet using a CAT-5 or Ethernet cable, available as an accessory for your unit.

- A. If connecting to a hub or switch, use a standard or “straight through” Ethernet cable.
- B. If connecting directly to a PC, use a “crossover” Ethernet cable.

Connect the other end of the cable to the host computer, hub, or switch.

Power on the Model 702i or 711i unit and log in as the **Administrator**.

Press the MENU button key to go to the menu, and move right to select the *Admin* menu.

If this is your first time using Ethernet communications from this unit, or you have moved the unit to a new network, you may need to enter information into the *Network Setup*. Otherwise, you will only need the IP address setting of the Model 702i or 711i unit for use in step 8 below.

Move down to select the first item, *Remote Mode*. Press the ENTER key to select remote operation.

Click on the Quantum™ hardware search icon  to open the **MCA Devices Auto Configuration** program.

Select **Ethernet**, **ANS Ethernet**, and **Quantum Ethernet**. Enter the IP address given to you by your system administrator or entered in Step 5.

Click the **Update** button. If the connection is successful, the version number and serial number will display on the **MCA Devices Auto Configuration** screen.

In addition to the reference information found in the Quantum software manual, detailed startup and calibration procedures can be found in the supplemental application notes in the "DOC" folder on the Quantum CD. Both PDF versions (for quick, on-screen reading) and Word documents (for better printing) are included. Start with the application note "QtmInitialCalibration," which includes software installation notes and hardware connection information.

Section
4

Specifications

Preamplifier

Type: Charge Sensitive
Input: Negative Current (anode)

ADC

Type: 14-bit pipelined
Speed: 50 MHz

Pulse Processing

Type: Digital, Trapezoidal Shaping
Peaking times: 40 ns to 5.1 μ s, factory set to 1.28 μ s
Gain: Digital, 0.25x to 16x
LLD: 0 to 100% of full scale, digitally adjustable in .006% intervals
ULD: 0 to 100% of full scale, digitally adjustable in .006% intervals
Zero: -5% to +5% of full scale, digitally adjustable

Spectrum Conversion

Collection Mode: Linear – 16384 Channels
Conversion Modes: Linear – 256, 512, 1024 Channels
QCC – 256, 512 Channels (U.S. Patent 5,608,222)

Note: If you are using the instrument without a PC, operation is limited to 256 and 512 QCC, including the saving of spectra. However, while under control of Quantum software, all ADC modes (including 1024 linear) are available.

System Controller

Processor: PPC405 CPU at 50 MHz
Display: 320 x 240 high contrast 32,000 color display with LED backlight
Controls: 7-key custom keypad
I/O: RJ-45 Ethernet port for computer connection
ENP3 series watertight connector for power and other functions
Clock: Battery backed-up clock/calendar

Power

Batteries:	Internal, 8 x 2450 mAh NiMH AA batteries
AC:	35W 12V or 15V universal AC adapter (depending on system revision)
Auto:	9V fused accessory adapter

Gamma Detector

702i Crystal:	5.1 x 3.8 cm (2 x 1.5 in.) NaI
711i Crystal:	3.8 x 3.8 cm (1.5 x 1.5 in.) LaBr

Detector Sensitivity

702i:	775 cpm/ μ R/hr (^{137}Cs)
711i:	650 cpm/ μ R/hr (^{137}Cs)

Energy Resolution

702i:	7-8% (^{137}Cs)
711i:	3.5-5% (^{137}Cs)

Energy Range

18 keV to 3 MeV

Bias

Integral HV supply from 0–1200 V
Actual operating voltage calibrated to each detector

Connection

Switchcraft 6-pin weathertight connector

Dimensions

25.1 x 11.4 x 22.1 cm (9.9 x 4.5 x 8.7 in.) (H x W x D) with handle

Weight

702i:	2.4 kg (5.2 lb)
711i:	2.2 kg (4.8 lb)

Section

5**Safety Considerations**

Environmental Conditions for Normal Use

Indoor or outdoor use

No maximum altitude

Temperature range of -20 to 50 °C (-4 to 122 °F)

Maximum relative humidity of less than 95% (non-condensing)

Installation Category II (Overvoltage Category as defined by IEC 1010-1)

Pollution Degree 2 (Normally only nonconductive pollution occurs. Temporary conductivity caused by condensation is to be expected.) (as defined by IEC 664)

Cleaning Instructions and Precautions

The instrument may be cleaned externally with a damp cloth, using only water as the wetting agent. Do not immerse the instrument in any liquid. Observe the following precautions when cleaning:

1. Turn the instrument OFF.
2. Allow the instrument to sit for one minute before cleaning.

Warning Markings and Symbols**Caution!**

The operator or responsible body is cautioned that the protection provided by the equipment may be impaired if the equipment is used in a manner not specified by Ludlum Measurements, Inc.

The Model 702i and 711i units are marked with the following symbols:



CAUTION (per ISO 3864, No. B.3.1) – designates hazardous live voltage and risk of electric shock. During normal use, internal components are hazardous live. This instrument must be isolated or disconnected from the hazardous live voltage before accessing the internal components. **Note the following precautions:**

Warning!

The operator is strongly cautioned to take the following precautions to avoid contact with internal hazardous live parts that are accessible using a tool:

1. Turn the instrument power OFF.
2. Allow the instrument to sit for one minute before accessing internal components.



The “**crossed-out wheellie bin**” symbol notifies the consumer that the product is not to be mixed with unsorted municipal waste when discarding. Each material must be separated. See section 6, “Recycling,” for further information.



The “CE” mark is used to identify this instrument as being acceptable for use within the European Union.

Section
6

Recycling

Ludlum Measurements, Inc. supports the recycling of the electronics products it produces for the purpose of protecting the environment and to comply with all regional, national, and international agencies that promote economically and environmentally sustainable recycling systems. To this end, Ludlum Measurements, Inc. strives to supply the consumer of its goods with information regarding reuse and recycling of the many different types of materials used in its products. With many different agencies – public and private – involved in this pursuit, it becomes evident that a myriad of methods can be used in the process of recycling. Therefore, Ludlum Measurements, Inc. does not suggest one particular method over another, but simply desires to inform its consumers of the range of recyclable materials present in its products, so that the user will have flexibility in following all local and federal laws.

The following types of recyclable materials are present in Ludlum Measurements, Inc. electronics products, and should be recycled separately. The list is not all-inclusive, nor does it suggest that all materials are present in each piece of equipment: batteries, glass, aluminum and stainless steel, circuit boards, plastics, and liquid crystal display (LCD).

Ludlum Measurements, Inc. products which have been placed on the market after August 13, 2005, have been labeled with a symbol recognized internationally as the “crossed-out wheellie bin.” This notifies the consumer that the product is not to be mixed with unsorted municipal waste when discarding. Each material must be separated. The symbol will be placed near the AC receptacle, except for portable equipment where it will be placed on the battery lid.

The symbol appears as such:



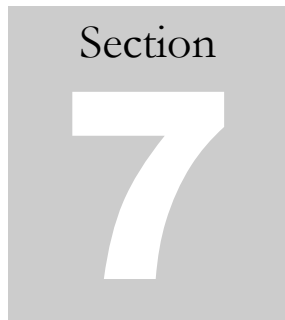

General Operation

Turning the Unit On and Off

Turn on the Model 702i or 711i unit by holding down the BACK / ⏻ key until the status screen appears. The instrument will automatically begin a self test, and the status will be indicated on the screen. (See Section 2 for more information about this screen.)

Scintillation detectors normally stabilize about 10 minutes after the power is turned on, assuming a stable temperature environment. However, the Model 702i unit has a built-in stabilization feature that will generally complete a recalibration within three minutes. During this time, it will display an informational message at the bottom of the screen indicating that a calibration is in progress.

Although data can still be collected while the unit is stabilizing in an emergency, the built-in analytical software may not make correct identifications during this time. When the informational message at the bottom of the screen goes away, the system is ready to use.

Whenever the Model 702i or 711i unit is turned off, all information is saved on the CompactFlash card, allowing you to restart the instrument without losing calibrations or other information. The real-time clock has a separate internal lithium battery that keeps it running even when there is no other power source.

To turn the instrument off, press and hold the BACK / ⏻ key. After one second, a message will appear and count down three seconds before the system turns off. In the rare event of a system lock-up, it may be necessary to hold the key down for a longer period of time (10 seconds) in order to engage the fail-safe, power-down mechanism.

Search Modes

The “search” modes are the modes normally used to detect the presence of radioactivity and determine its location. They respond quickly and make it easy to tell if something has changed, but give less detailed analytical results. In these modes, the instrument continuously takes readings, searches for isotopes, and analyzes them for dose rate and other measurements.

There are four search modes available – *Dial*, *Finder*, *Bars*, and *Spectrum*. Only *Dial* and *Finder* are enabled by default when logged in as **User**. However, your **Administrator** may change which screens are enabled, so that it is easier to quickly access the most important information for your particular response plan.

There are a number of elements that appear on all search mode screens. These are shown on the *Dial* screen in Figure 6.

In the upper-left corner is a battery icon, which appears green when the batteries have at least 10 minutes of useful life remaining. It appears yellow when the batteries have between 5 and 10 minutes left, and it appears red when the batteries have less than 5 minutes left. When the time is short, the battery icon will indicate a remaining time in hours and minutes. Please note that these times assume the system is running on the factory-provided batteries, and are approximated times, as the battery life can change with use and from one charge cycle to another.

Just to the right of the battery is a calibration indicator. On initial power-on, this box will fill in with orange until enough data has been collected to ensure that the system is calibrated. Then the box will turn green, with a small pointer indicating the rate of calibration drift.

In the top center the screen displays the clock time. It is important to have this time set correctly, including your time zone, so that the stored spectra will have the correct time recorded.

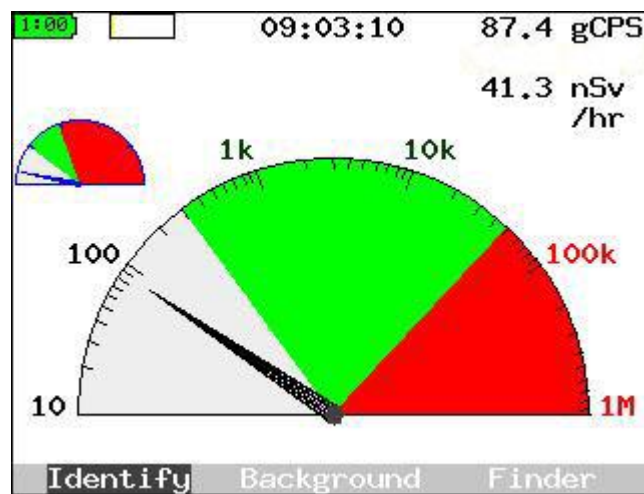

Figure 6 - *Dial Search Mode Screen*

The numbers in the top right corner indicate the count rate for gamma rays and the current dose rate. These help associate specific numbers with the visual elements of the dial. This version of the display is shown in Figure 7.

Finally, at the bottom of the screen you will see three soft keys: **Identify**, **Background**, and one additional choice that allows you to move to the next search display mode. (On systems where only one mode is enabled, only the first two keys will be shown.)

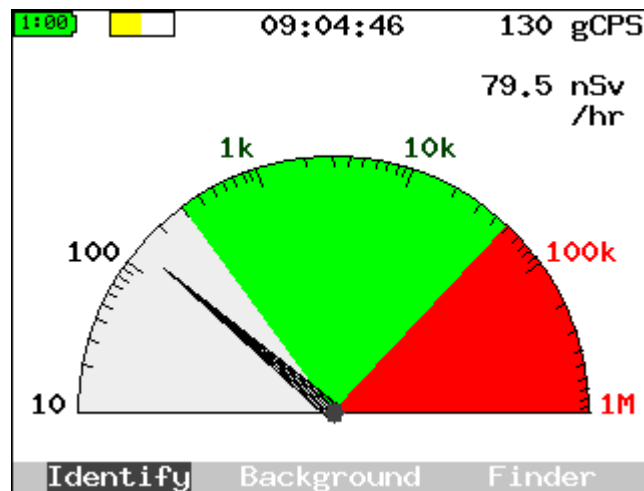

Figure 7 - *Dial* Search Mode Screen

The main purpose of the *Dial* screen is to provide a quick visual indication, similar to that given by a handheld dosimeter or Geiger counter, showing the amount of radioactivity being measured. When the dial pointer is in the gray area, there is little radioactivity present. Most of the counts are coming from either cosmic rays or naturally occurring sources such as ^{40}K .

Once the pointer moves up into the green area there is an indication of some unusual activity. Within the green area, an **Identify** operation should be started. Finally, if the pointer moves into the red area, the activity is too high for a correct identification. It is *strongly advised* that you move back from the radioactive source, if at all possible, before attempting to identify it.

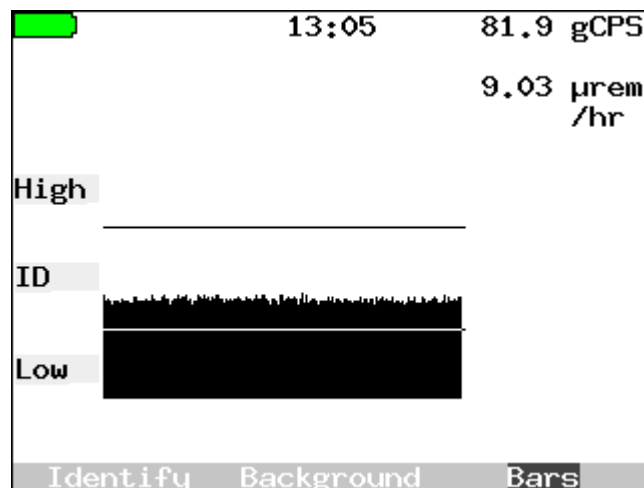

Figure 8 - *Finder* Search Mode Screen

The *Finder* screen shows a similar type of count-rate based information. However, it is displayed as part of a bar graph that continually moves to the left at 10 steps every second. The full chart displayed on the screen represents approximately the last 20 seconds. This mode can be extremely helpful when you are walking through an area looking for a radioactive source. The system is giving you “cold/warmer/hot” feedback as you move, so that you can localize the source effectively. Once you have narrowed in on the source, you should do an **Identify** operation. The “low” area shown on the screen corresponds to the gray area on the *Dial*. The “ID” area matches the green portion, and the “high” area matches the red portion. **Identify** will be most effective when the top of the rolling chart is falling within the ID area.

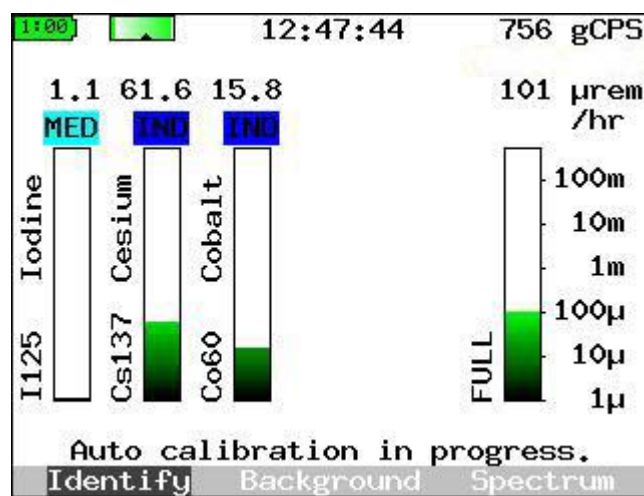

Figure 9 - *Bars* Search Mode Screen

The *Bars* screen provides a very different sort of information, organized around *what* is present rather than *how much*. The numbers at the top right still indicate the count and dose rates, but the individual bars indicate the different radioisotopes that are thought to be present. The symbol and name of the isotope are listed to its left. Above each bar is a “class” indication. Each bar shows an estimated dose rate attributable to that particular isotope.

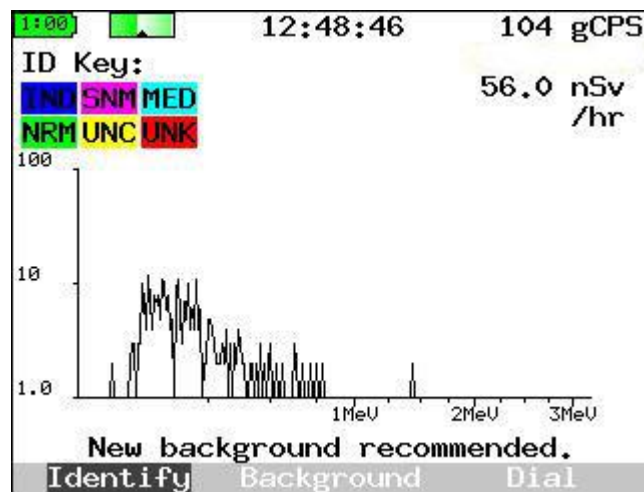

Figure 10 - *Spectrum Search Mode Screen*

The *Spectrum* screen is designed for users with a health physics background to see the data collection and statistics in real time. Certain changes in the spectrum shape, such as that produced by beta particle interactions, can be interpreted by the trained eye, even when it cannot be identified by the automated algorithms. This screen provides a dynamic display for this particular set of users.

Audible Search Setting

All of the search modes described above are visually oriented. However, there may be times when watching the display screen is inconvenient, either because you need both hands free for other activities, or because you need a more inconspicuous way to monitor for radiation. In addition, the human ear is surprisingly sensitive to changes in rate, so you may find that you can better tell whether you are seeing abnormal radioactivity by enabling the audible output.

The *Audible Count Rate* setting in the *Field Settings* menu turns on a click that increases in frequency along with the input count rate. This sound continues as long as the instrument is collecting data, so it also gives feedback when you are in menus and other screens that do not show count rate information.

Note: Enabling the *Audible Count Rate* may noticeably reduce your battery life.

Taking a Background

To ensure accurate results, it is very important to take frequent background spectra in the actual monitoring location. The background is the point of reference against which readings are measured, and corrects for ambient radioactivity or background radiation from cosmic rays in the area of the detector.

The ambient background spectrum is stored and then subtracted from all other collected spectra on a channel-by-channel basis before they are analyzed.

It is easy to take a new background on the Model 702i or 711i unit. Simply select the **Background** soft key and press ENTER. First, the system will remind you to ensure that any known sources of radioactivity are properly stored or shielded, as shown in Figure 11. Whenever you are ready, you can **Continue**. If you need more time, you can **Wait** or even **Cancel** if necessary. If the countdown completes, the system will continue for you.

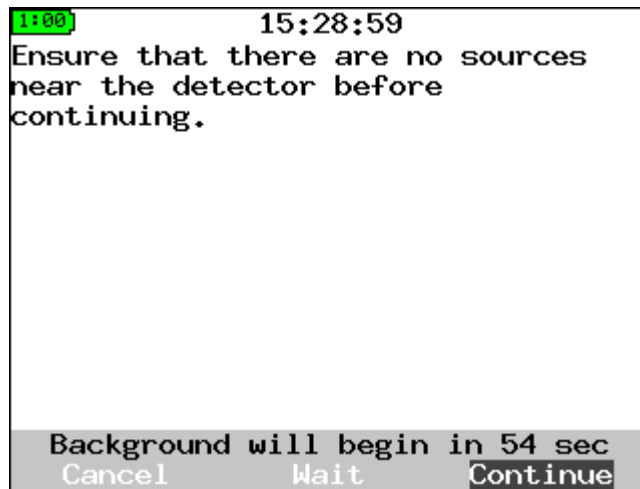

Figure 11 - Collecting Background - Instructions to Remove Sources

Once you continue, you will see a display like that shown in Figure 12. Initially, the graph will be fuzzy (lack of statistics), but it should smooth out as time goes on. If you wish to collect a longer background, you can increase beyond the default time by selecting **+30 s**. Holding down the ENTER key will rapidly increase the collection time. You also have the option to shorten the collection time, to **Cancel** at any time, or to **Erase** (for example, if you believe that you have forgotten to shield all sources in the vicinity). When this new countdown completes, the system will be ready for operation.

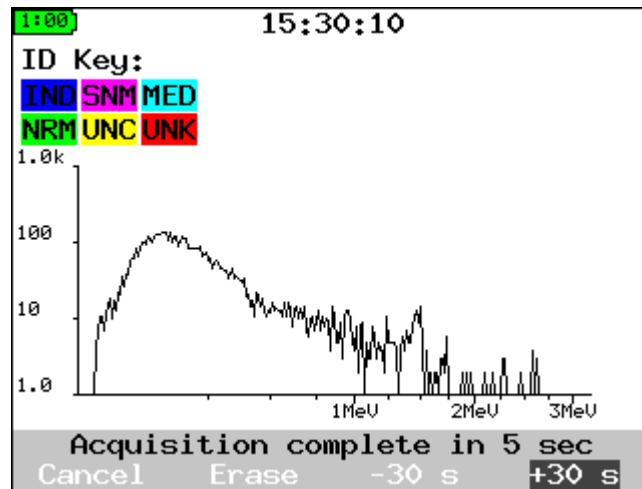

Figure 12 - Collecting Background - Typical Spectrum

Background spectra can be acquired at any point, and should be taken:

Whenever the ambient background changes (for example, if the instrument is moved to a new location).

Every week, as prompted by the unit.

Because the counting statistics in the background spectrum directly affect the uncertainty in the analyzed spectra, the background should be counted for as long as or longer than the acquisition time.

Normal readings will have significant variations based on location and detector size. Only with experience can the user determine what "normal" cpm readings are. The most likely causes for high background readings are:

The presence of radioactive materials near the system in the form of samples or standards.

High concentrations of natural radioactive material such as ^{40}K in the building materials.

Less likely causes include:

High radon levels.

Identifying Sources of Radiation

Once the Model 702i or 711i unit has helped you locate a radioactive material, it can help you determine the specific material that is present. The system has an internal library of over 85 nuclides. However, at any given time, only the subset defined by the current *Trigger List* is enabled. You can change to different trigger lists by using the *Select Trigger List* item in the *Field Settings* menu.

To collect data for identification, simply select the **Identify** soft key on the search mode screen. The system will immediately begin to collect data for identification. An example is shown in Figure 13, with the industrial nuclide ^{137}Cs present. As soon as the system has identified the nuclide(s) present, it will color in the peaks with their appropriate class color: blue for industrial (IND), magenta for special nuclear materials (SNM), cyan for medical (MED), and green for naturally occurring radioactive materials (NORM or NRM).

Do not be concerned if some parts of the display are marked in yellow – these are an indication that the system is uncertain whether there is an actual signal or “peak” present in the spectrum. If you wish to eliminate these uncertainties, you can extend the collection time by using the **+30 s** soft key until the uncertainty has been resolved, but this is rarely necessary.

When there is a definite peak present but it does not match any nuclide on the current trigger list, it will be labeled in red, for unknown (UNK). In this event, it may be valuable to re-analyze the data with another trigger list, to see if the relevant nuclide was not enabled. If no analysis can be found, it may be time to consider sending the spectrum to an outside facility for identification.

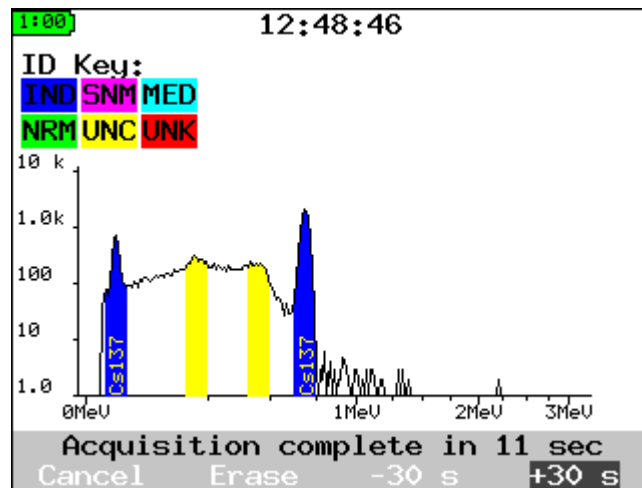

Figure 13 - Identify in Progress with ^{137}Cs

Once identification is completed, an analysis report will be presented, as described in the next section.

Analysis Report

The analysis report gives the results of a detailed analysis of the collected data. An example of this is shown in Figure 14. Different details of this report may be enabled for different applications.

```
1:00 09:22:50
Analysis Report
Acq Date: 16-Nov-2006
Type: CAPT. ALARM
Live Time: 20.0 sec
Dose Rate: 312.5 µrem/hr
Gamma ctrt: 2652.6 CPS
Neut ctrt: 0.1 CPS
Nuclide Class DoseRt Conf
Cs137 IND 230.8 99%
Bias setpt: 1066 V
ADC xform: QCC
Coarse gain: 1
Fine gain: 2.325
```

Figure 14 - Sample Analysis Report of ¹³⁷Cs

The initial part of the report shows the date the spectrum was acquired, the type (a manually captured alarm), the collection time, and the same dose rate and count rate information normally shown on the main screen.

Immediately after these, the “found nuclides” report is shown, which gives some of the most critical information. It shows the name of any suspected nuclides, the class identification, the nuclide-specific dose rate (in the same units as above), and the confidence in this particular identification.

The final lines in the report detail the hardware settings used in the data collection process.

Storing, Reviewing, and Retrieving Spectra

Spectra are automatically saved whenever an **Identify** process is completed. Spectra are also saved for each background taken and for certain other operations like fine energy calibration. The Model 702i and 711i can store nearly 10,000 spectra in its “catalog.” Each stored alarm consists of a spectrum and all the information necessary to analyze it. They are stored in a standard format designed to comply with ANSI N42.42.

You can review and (when desired) erase these spectra using the *Spectral Data* menu.

Section
8

Manual Calibration

Occasionally, you may find it desirable to recalibrate your instrument manually, rather than relying on the built-in calibration mechanism. We recommend doing this calibration under the following circumstances:

Perform a *Coarse Calibrate with ^{137}Cs* and a background spectrum acquisition when you first install the instrument on site. Although the instrument is factory calibrated, the on-site calibration helps ensure accurate results

Perform a coarse adjustment whenever the unit has been subjected to a severe temperature change, such as from the trunk of your car to the inside of a building. This is particularly important if the unit was turned off at one temperature (e.g. indoors) and turned on again at another (e.g. right after spending a long time in your car).

Coarse Calibration

The recalibration procedure described in this section automatically adjusts hardware parameters (for example, high voltage and amplifier gain) to obtain an accurate system energy calibration. It requires one radioactive source, a license-exempt ^{137}Cs source of approximately 0.5 to 5 μCi .

To begin the process, you must enter the menu system by pressing the MENU button. You should immediately see a *Field Settings* menu that looks similar to Figure 15. By pressing the UP or DOWN arrow keys, move the selection so that *Coarse Calibrate with ^{137}Cs* is selected. Press ENTER to begin the calibration.

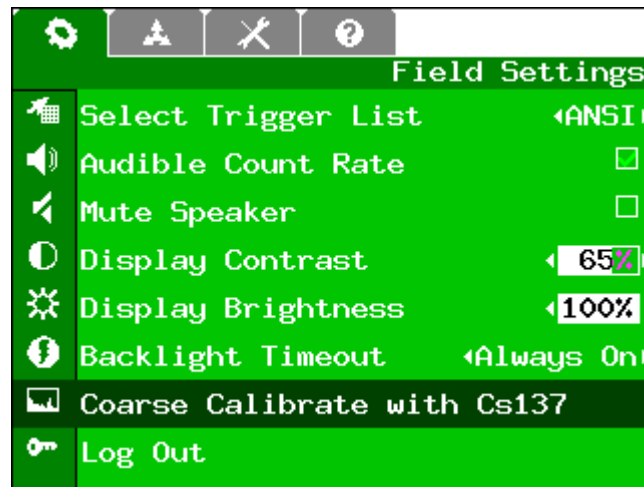

Figure 15 - *Field Settings* Menu with *Coarse Calibrate* Selected

You will now be prompted to place the ^{137}Cs source near the detector, as shown in Figure 16. If you do not have the source nearby, you can ask the system to **Wait** (give you an extra minute) or **Cancel** if you made a mistake.

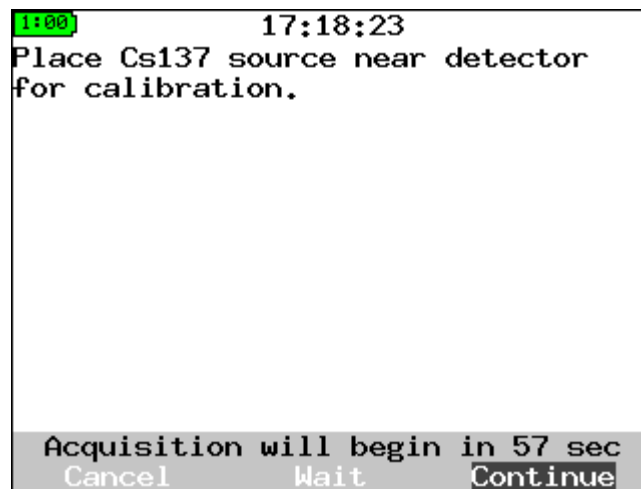

Figure 16 - *Coarse Calibrate* Source Placement Dialog

Once you **Continue** (or allow the countdown to complete) you will see a screen that looks similar to the one shown in Figure 17. This process may repeat several times as the system updates different parameters to ensure that your calibration is as close as possible to the target calibration. The target calibration is shown by the two blue/gray lines near the centers of the peaks. Do not be concerned if the parameters shown in the message area above the soft keys are different. They are unique to each detector type and detector.

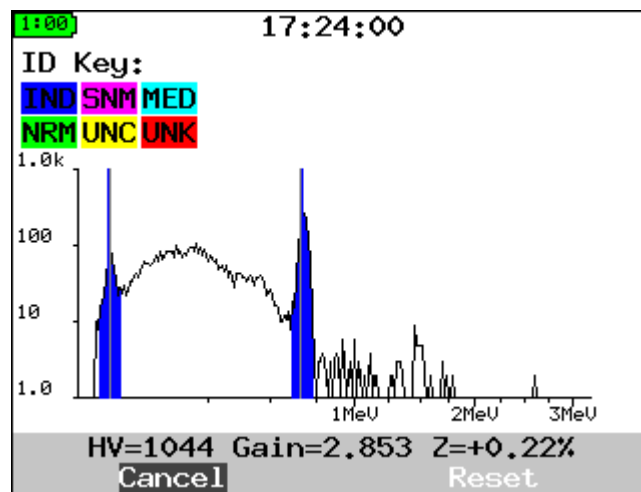

Figure 17 - *Coarse Calibrate Collecting Data*

When the process is complete, the system will beep three times (unless you have the sound turned off) and return to the *Field Settings* menu.

If for some reason your system is having trouble seeing the peaks, (for instance, if the peaks are already far to the right of where they should be) you can also select the **Reset** soft key to initialize all the parameters to defaults. Please be aware that resetting all the parameters will make the calibration take a much longer time than normal. If the calibration does not look right or is taking too long, you can always **Cancel** and go back to the previously stored calibration.

Dose Rate and Fine Energy Calibration

Your system has two additional calibrations that are performed at the factory. One corrects the dose rate for individual variations in the detector efficiency; the other ensures that the energies of measured radiation lines are correct across the entire spectrum.

If for some reason you believe these calibrations are no longer correct, or if your regulations require periodic recalibration of the instruments with NIST-traceable sources, please contact LMI for more information.

Section
9

System Menus

Introduction

Before describing each of the different menus in detail, this section shows and explains how to choose the menu, how to choose an item within the menu, and how each of several standard menu editing operations works.

First, to enter the menu system, you must press the MENU key while in one of the search mode screens.

When you first enter the menu system, you will start with the *Field Settings* menu. Figure 18 shows the menu “tabs” that would be present for the **User** log-in. The left-most tab corresponds to *Field Settings*, and so it is shown highlighted in color, while all the other (unselected) tabs are shown in gray. The name of the menu, “Field Settings,” also appears just below the tabs, as shown. To change to another menu when the tab is selected, you may use the RIGHT and LEFT arrow keys. (In this case, the RIGHT arrow key will take you to the *Spectral Data* menu, while the LEFT arrow key will also wrap around and bring you to the *Help* menu.) If you are somewhere in the middle of a menu, and want to quickly return to the tabs, you can press the MENU key to do so.



Figure 18 - Example of Menu Tabs

To select an item from the menu, press the UP or DOWN arrow keys. Pressing the Down arrow when on the tab will take you to the first item on the menu. As a shortcut, pressing the Up arrow when on the tab will take you to the *last* menu item.

To return from the menu system to the search mode, you can use the BACK key (unless you are running a procedure or editing a specific item), or you can select the *Exit* item at the bottom of each menu.

We will now elaborate on how to make changes for various different types of menu items.

Run a Procedure/Display Information/Open Submenu

Perhaps the simplest type of menu item is one that runs a procedure, displays information (such as a help file), or opens a sub-menu. These all look the same on the screen, except for the name of the menu item. The *Coarse Calibrate with ¹³⁷Cs* item is shown here as an example.



To perform the listed task, simply move the highlighted area (darker background) onto this menu item, and press ENTER. In the case of a procedure-like calibration, the first step of the procedure will then be displayed. For a help menu item, the associated help text is displayed.

Check Option On or Off

Another simple procedure is to turn an option on or off. For these items, a check box is shown, as in the example of the *Audible Count Rate*.



To change whether the option is enabled or not, highlight the menu item and press ENTER to toggle the check mark. Alternately, the LEFT and RIGHT arrows will also toggle the check mark.

Adjust Slider

A few features, particularly display contrast and brightness, are set with sliding adjustments like the ones you might find on your PC monitor. The *Display Contrast* is shown as an example here.



To change the value, highlight the item and press the LEFT arrow to reduce the value, or the RIGHT arrow to increase it. The value is shown both in percent and as a bar that goes from empty (0%) to full (100%). The small arrows shown on the screen are a reminder that LEFT and RIGHT are the keys you use to make a change.

Select Among Options

Some items give you a choice among different static options. *Select Trigger List*, shown here, gives you several standard options to choose from.



Pressing the LEFT or RIGHT arrow will change to the previous/next item in the list. The small arrows shown on the screen are a reminder that LEFT and RIGHT are the keys you use to make a change. In cases where there is no particular order to the list, you can continue flipping through items until you come back around to where you started. For other items, like time intervals, there may be a minimum and maximum value. When the minimum is reached, the left arrow disappears from the screen and LEFT will no longer make a change; the same is true for RIGHT when the maximum is reached.

Isotope List

All Isotopes in Library

¹¹ C	¹³ N	¹⁸ F	²² Na	²⁴ Na	⁴⁰ K	⁴² K	⁴³ K
⁴⁶ Sc	⁴⁸ V	⁵¹ Cr	⁵² Mn	⁵⁴ Mn	⁵² Fe	⁵⁹ Fe	⁵⁵ Co
⁵⁷ Co	⁵⁸ Co	⁶⁰ Co	⁶⁴ Cu	⁶⁷ Cu	⁶⁵ Zn	^{69m} Zn	⁶⁷ Ga
⁷² Ga	⁷² As	⁷⁴ As	⁷⁶ As	⁷⁵ Se	⁷⁷ Br	⁸¹ Rb	⁸⁴ Rb
⁸⁵ Sr	⁸⁹ Sr	⁸⁶ Y	⁸⁸ Y	⁹⁹ Mo	^{99m} Tc	¹⁰³ Pd	¹⁰⁹ Cd
¹¹¹ In	¹¹³ In	¹²² Sb	¹²⁴ Sb	¹²⁵ Sb	¹²³ I	¹²⁴ I	¹²⁵ I
¹²⁹ I	¹³⁰ I	¹³¹ I	¹³³ I	¹³³ Xe	¹³⁴ Cs	¹³⁷ Cs	¹³³ Ba
¹³⁷ Ba	¹⁴⁴ Ce	¹⁵³ Sm	¹⁵² Eu	¹⁵⁵ Eu	¹⁶⁹ Yb	¹⁹² Ir	¹⁹⁸ Au
¹⁹⁹ Au	¹⁹⁷ Hg	²⁰³ Hg	²⁰¹ Tl	²⁰⁴ Tl	²⁰⁸ Tl	²⁰³ Pb	²¹⁰ Pb
²¹² Pb	²¹⁴ Pb	²⁰⁷ Bi	²¹² Bi	²¹⁴ Bi	²²⁴ Ra	²²⁶ Ra	²²⁸ Ac
²³² Th	²³⁴ Th	²³⁴ Pa	²³³ U	²³⁵ U	²³⁸ U	²³⁷ Np	²³⁸ Pu
²³⁹ Pu	²⁴¹ Am						

* OTH (Other) Library is composed of all isotopes from the main full list, not included in any other list selection.

Edit Numeric Value

A few options, particularly those available to the **Administrator**, are numeric values that may need to be changed. The *Dose Rate Alarm Level* setting is shown here.



Ⓜ Dose Rate Alarm Level 50000.00

There are two mechanisms for changing these values. When the menu item is first highlighted, pressing the LEFT key will reduce the value to a smaller value – sometimes half, sometimes another convenient interval – until it reaches a minimum setting. Pressing the RIGHT key will increase the value up to a maximum.

If the existing steps are not satisfactory, you may change the value one digit at a time by entering the “free edit” mode. This is done by pressing Enter while the menu item is highlighted; you will see the display change to appear like the display here:



Ⓜ Dose Rate Alarm Level 50000.00

Once in this mode, LEFT and RIGHT move to different digits, and UP and DOWN change the currently highlighted digit. In order to accept your changes, or in order to use UP and DOWN to move to the next menu item, you must press ENTER. This will save the current value and put you back in the normal menu-browsing mode.

Edit Date for Filter

When choosing a date for *Spectrum Search Criteria* menu, the menu item works in a way similar to the Edit Numeric Value function. Initially, *Any* date is allowed.



Earliest Date ‹Any›

If you wish to make a restriction, so that fewer dates match, you must edit the value. Pressing an arrow key will change the date to today's date; pressing an arrow key again will change it back to *Any*. To edit the date, you must press ENTER.



Earliest Date 03/12/07

While in this mode, you can change each portion of the date by using the UP and DOWN arrow keys. (Note that the actual format of the date may vary depending on your *Language* choice.) When pressing UP or DOWN, a U.S. date format, as currently shown, will change the month to April or February. Pressing the LEFT and RIGHT keys will change to another field. When you have the date you would like, press ENTER to return to the normal mode.

Note that if you press the LEFT and RIGHT arrow keys again, the date will change back to *Any*. However, the system will remember the date you entered, and if you press the arrow key again, you will get back your edited date.

User Menus

Four menus are available to the **User**: *Field Settings*, *Spectral Data*, *Config*, and *Help*. The items on these are the ones most often needed in general operation. The same menus appear for the **Administrator**, but may have additional options shown. All the common options are described in this section, and only the new ones for the **Administrator** are described in the Administrator Menus section.

Field Settings

Figure 19 shows the **User** *Field Settings* menu. This is the first menu shown and thus the easiest one to access, and is intended to put all of the most frequently used items at the user's fingertips.

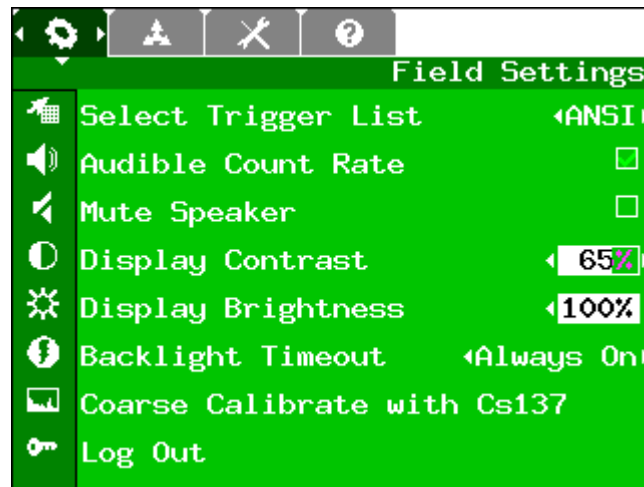

Figure 19 - User's *Field Settings* Menu

Select Trigger List

The “Trigger List” is the list of all of the nuclides that are currently enabled for detection and analysis. Knowing the kind of nuclides you normally search for will help reduce false identifications. There are five standard lists included, although your **Administrator** may choose to have different options available. These are:

ANSI – standard nuclides from ANSI N42.34.

BNC – list of common check sources and “laboratory” isotopes

MED – list of medical isotopes, normally a subset of the ANSI list

IND – list of industrial isotopes, normally a subset of the ANSI list

SNM – list of special nuclear materials, normally a subset of the ANSI list

In addition to changing lists with LEFT and RIGHT, pressing ENTER will display the contents of the currently selected list. You can press ENTER again to return to the menu.

Audible Count Rate

This option simply turns on and off the audible clicks that indicate the count rate. It is important to note that if the speaker is muted (see next item), you will not hear these clicks. Generally, you should hear the clicks as soon as you check the check box.

Mute Speaker

This option turns on and off the internal speaker – when the box is *checked*, the speaker is *off*.

Display Contrast

The display contrast may be increased or decreased. This option may aid readability after large temperature changes. Not all units have this option – if it does not appear, the setting is done internally at the factory.

Display Brightness

This setting increases or decreases the brightness of the display “backlight.” Because the display backlight is one of the largest consumers of battery power, changes to this setting can significantly impact your battery life. It is recommended that this be set to the lowest setting that still gives a comfortably readable display.

Backlight Timeout

You can set the timeout for the display backlight. The backlight will turn off if there is no activity for this amount of time. To turn the backlight on again, press any key. Again, because backlight use increases the battery discharge rate, using small timeout settings will give longer, useful battery life.

Coarse Calibrate with ¹³⁷Cs

This operation performs a manual calibration, as described in Section 8.

Log Out

This operation takes you back to the *Login* screen. You can then log in as **User** or **Administrator**.

Spectral Data

Figure 20 shows the *Spectral Data* menu. The items on this menu allow you to navigate through the stored spectra, search for particular spectra, review, and delete those spectra. This menu is the same for both **User** and **Administrator** modes.

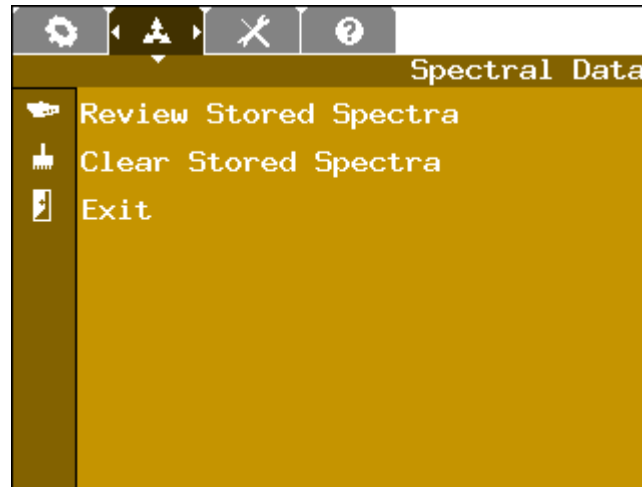

Figure 20 - *Spectral Data* Menu

When either the *Review Stored Spectra* or the *Clear Stored Spectra* operation is chosen, the next screen brought up is a sub-menu that is used for searching the catalog of stored spectra, as shown in Figure 21. As you can see, this menu is shown in gray rather than color, indicating that it is a sub-menu of another menu operation.

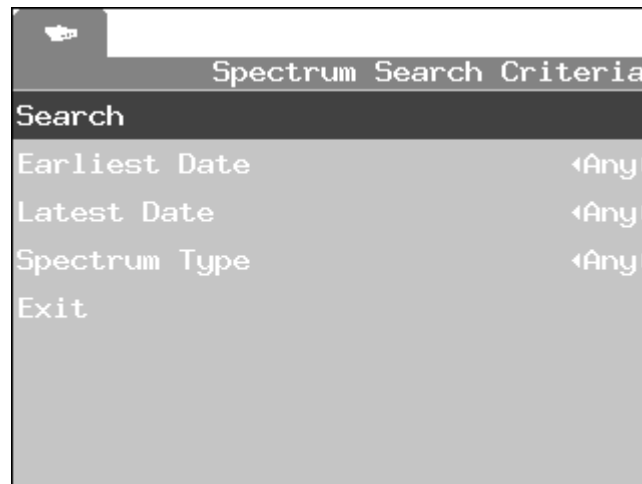

Figure 21 - *Spectrum Search Criteria* Submenu

In this menu, you can set the *Earliest Date* and *Latest Date* for the search, so that only a specific set of spectra are considered. You can also restrict the search to a single *Spectrum Type*, such as “captured alarm” or “background,” or leave it open to any type. The default settings shown above will include every spectrum in the catalog. Once you have set any search limits you want, you must highlight the *Search* item as shown in Figure 21 and press ENTER to continue to the next step, the selection of individual spectra.

The next sub-menu is shown in Figure 22. This menu gives you the opportunity to accept or reject individual spectra. This step may be less important when displaying spectra, especially if your filter is very narrow. However, when clearing spectra, you must individually go through and check each spectrum that you wish to clear, as a confirmation that you really wish to delete that spectrum permanently. (Note: When clearing spectra, you can never check the currently used background spectrum, as indicated by a red “X” in the check box.)

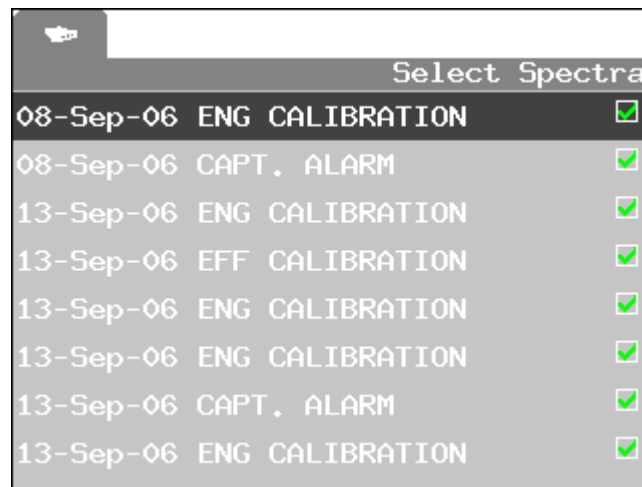

Figure 22 - *Select Spectra* Submenu

Once you have checked all the spectra, you must select the *Display* or *Erase* item at the very end of the menu. To quickly access this item, you may wish to go to the top of the menu (by pressing MENU if needed) and hit the UP arrow once to take the shortcut to the last item.

If you are clearing spectra, the process will complete and return you to the *Spectral Data* menu. However, if you are reviewing spectra, you will instead see a screen similar to the one shown in Figure 23.

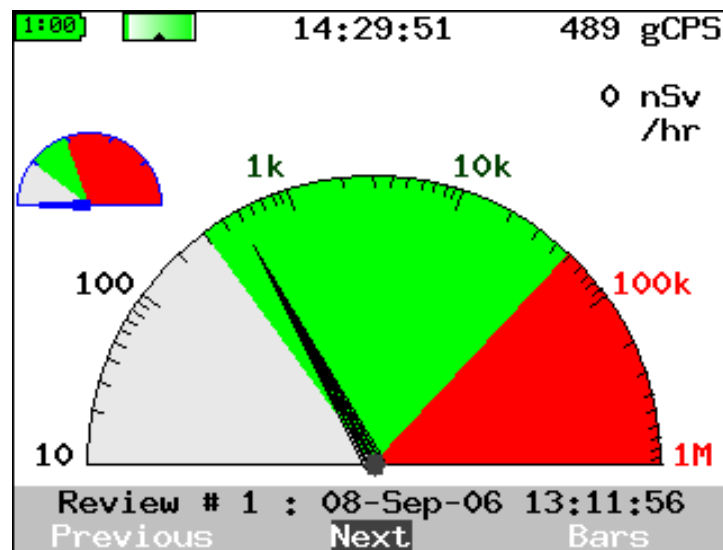
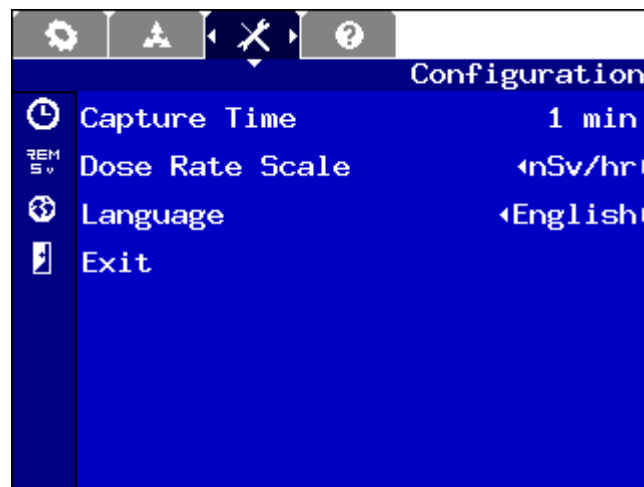

Figure 23 - Review Mode Dial Screen

This display shows much of the same information as the search mode *Dial* screen, but for the spectrum being reviewed rather than for the live data. The soft keys **Previous** and **Next** will take you through the list of spectra you selected in the previous step (Figure 22), and the third item will let you see **Dial**, **Bars**, and **Spectrum** views of the data. (There is no equivalent to **Finder** because this requires time-series data.)

Configuration

The **User** configuration menu is very short, and contains only a few of the items shown on the **Administrator** version of the same menu. The **User** version of the menu is shown in Figure 24.

Figure 24 – User's *Configuration* Menu

Capture Time

The capture time setting determines the default for run time for the **Identify** operation. You can either change the default time here, or increase or decrease the time from the **Identify** screen itself.

Dose Rate Scale

This setting changes the preference for the display of dose rates. There are four options: $\mu\text{rem}/\text{hour}$, mrem/hour , $\text{nSieverts}/\text{hour}$, and $\mu\text{Sieverts}/\text{hour}$. These are abbreviated on-screen. All dose rates are stored internally in the same units, so this has no effect on stored data, but only on the way it appears on the display. When viewing the full **Administrator** menu, you will see that the dose level settings also change to match the currently selected unit value.

Language

This allows you to select among different user interface languages. Full support for languages other than English may require an upgrade package. Consult factory for details.

Help Menu

The *Help* menu provides in-system help for many of the features described in this manual. Each item in the menu is a separate help topic that can be read using a scrolling help viewer. A typical *Help* menu is shown in Figure 25.

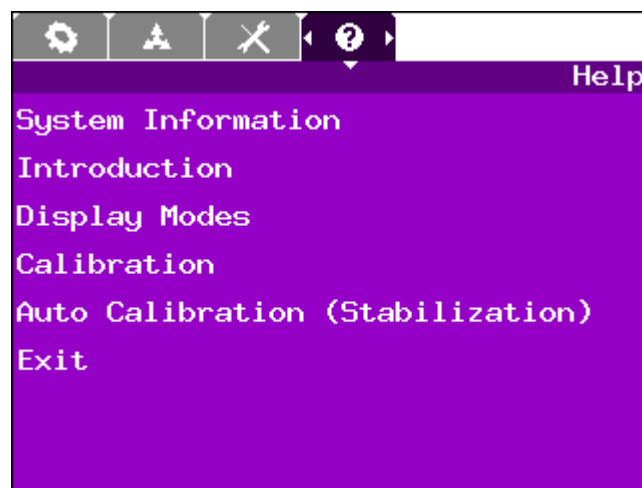

Figure 25 - *Help* Menu

To access any help item, highlight that item and press ENTER. If a scroll-bar is shown on the right, you may wish to scroll through the text using the UP and DOWN arrow keys. When you are done reading the help item, press ENTER again to return to the menu.

Administrator Menus

The **Administrator** has not only additional menus, but additional menu items on the *Configuration* menu. These allow the system to be customized for a particular application, while still providing only the most frequently used items to the **User**.

Configuration (Extra Items)

The **Administrator** *Configuration* menu is shown in Figure 26. The last three items are identical in function to those found for the **User**. The additional items are described below.

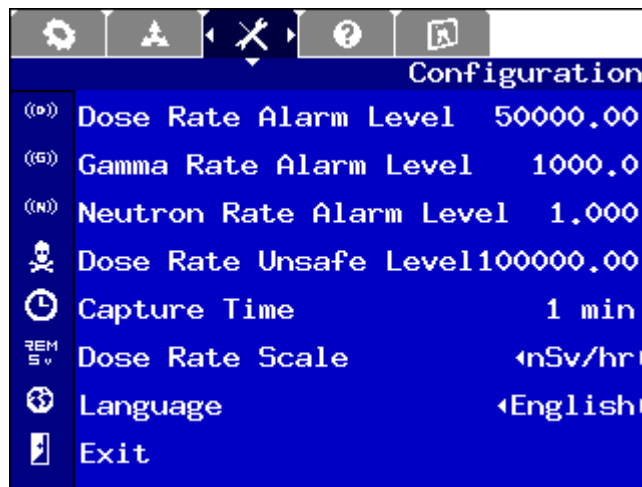

Figure 26 - Administrator's *Configuration* Menu

Dose Rate Alarm Level

This setting determines the dose rate required to set off the dose rate warning alarm. This is specified in the units given by the *Dose Rate Scale* further down in the menu. The system will flash the screen and sound an audio alert when this level is reached.

Gamma Rate Alarm Level

This setting determines the gamma count rate in counts per second (cps) that will set off the gamma warning alarm. Although this has some functional overlap with the dose rate alarm, there may be cases where a low-energy source with a high count rate would set off

this alarm but not the dose rate alarm. The system will flash the screen and sound an audio alert when this level is reached.

Dose Rate Unsafe Level

This setting determines the dose rate that will set off the personnel protection or “turnback” alarm. This is specified in the units given by the *Dose Rate Scale* further down in the menu. The system will flash the screen red and sound a distinctive audio alert when this level is reached.

Admin

The *Admin* menu is shown in Figure 27. This menu contains utilities for setting up the instrument and changing the protections of the various modes.

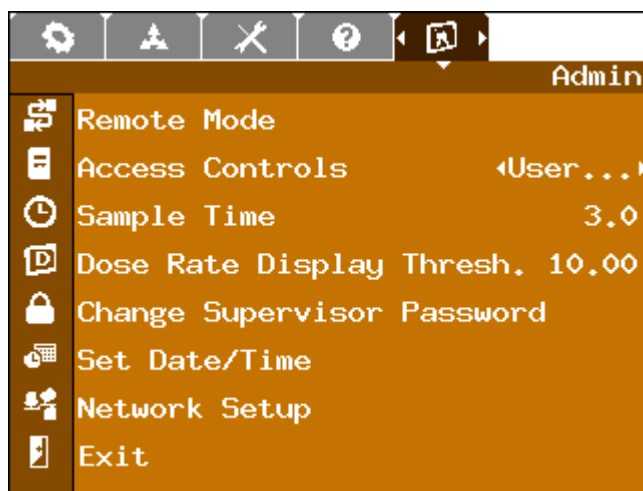

Figure 27 - *Admin* Menu

Remote Mode

This operation puts the unit into a remote communications mode.

Access Controls

This item brings up a submenu for the currently selected log-in, either *User* (as shown above) or *Admin*. The login can be selected using the LEFT or RIGHT arrow keys. The submenu is shown in Figure 28 and Figure 29.

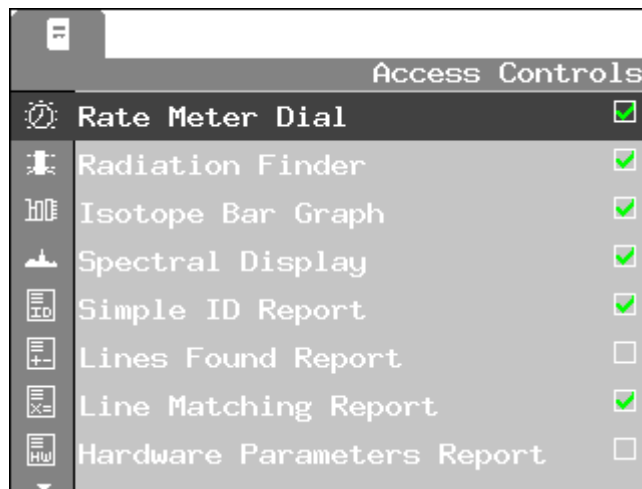

Figure 28 - Access Controls Submenu, Part 1

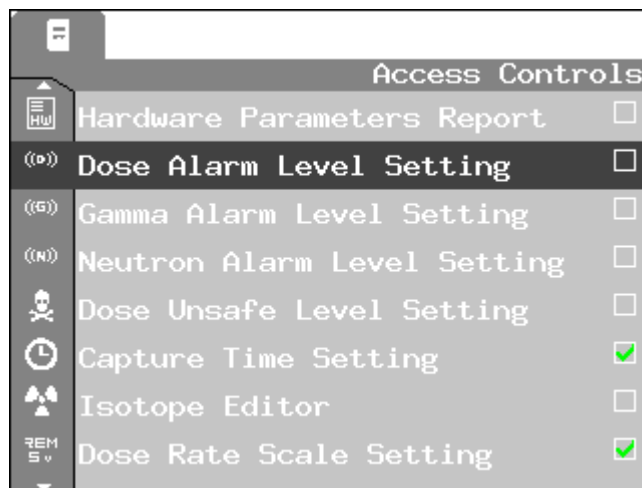

Figure 29 - Access Controls Submenu, Part 2

Each of the items shown corresponds to a different feature that may be either enabled or disabled for the selected log-in. *Rate Meter Dial* through *Spectral Display* determine which search modes are enabled. The four *Report* items enable and disable separate sections of the on-screen report. The *Level Setting* items, *Capture Time Setting*, and *Dose Rate Scale*

Setting items are features that appear in the *Configuration* menu, so that additional items may be added or removed for **User** access. The *Isotope Editor* function is not supported in the product and has no effect.

Sample Time

The Model 702i and 711i collects and analyzes spectra in real time. The *Sample Time* is the spectrum acquisition time, sometimes called the time slice. The recommended minimum sample acquisition time is one second; however, a three to five-second setting is recommended for dose rate monitoring. Select a short sample if a quick response is required. Select a longer time if more averaging is desired or to reduce stray bars displayed in the *Bars* mode.

Dose Rate Display Threshold

This setting applies only to the *Bars* mode. It determines the minimum per-isotope dose rate that is required before a bar will be displayed. Once the dose rate reaches this level for one *Sample Time* period, the bar will appear. (It will then remain on the screen for up to 30 seconds, even if the level falls below the threshold again, to make the display easier to follow visually.)

Change Supervisor Password

The password used for the **Administrator** log-in may be changed by the **Administrator**. To do this, you must enter the old password first, and then enter the new password, as shown in Figure 30.

```
Change Supervisor Password
Enter original password to access
this function.

Orig Passwd:   PASSWORD
New Passwd:   NEWPASS█
```

Figure 30 - Changing Password

Set Date/Time

Because the Model 702i and 711i records the date and time of every spectrum collected in Universal Coordinated Time (UTC), it must not only know the date and time but also the current time zone. All of these are set from this menu item, which opens the dialogue shown in Figure 31.

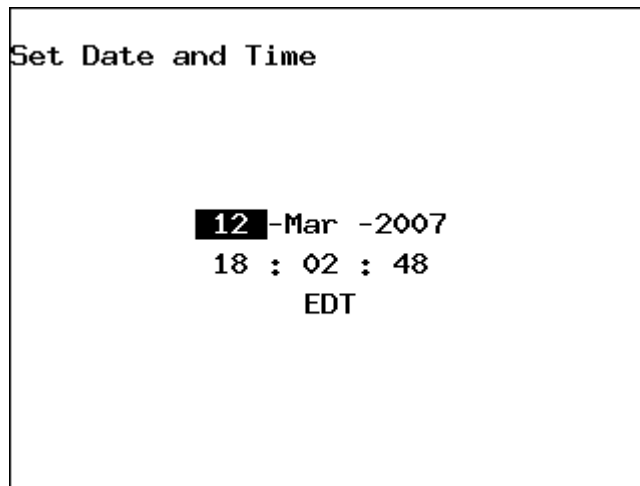
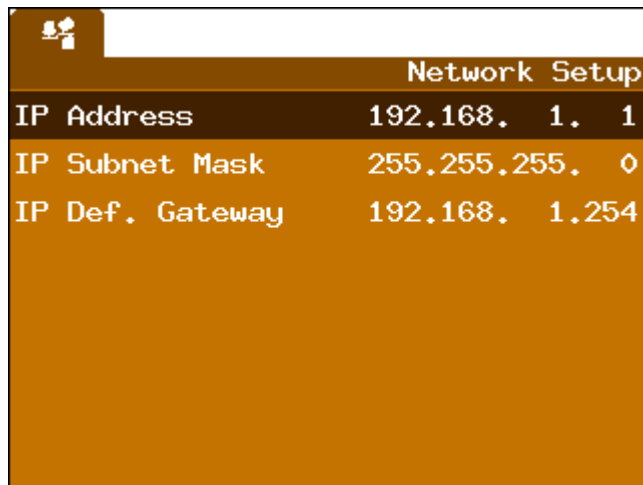

Figure 31 - Setting Date and Time

Use the LEFT and RIGHT arrows to move from one field to the next. To increase or decrease the value of a particular field, use the UP or DOWN arrows, respectively. It is recommended that if you need to change the time zone, you do this first. The hour (and possibly minute) will be automatically updated when you make this change. Finally, press ENTER to accept the currently shown date and time.

Network Setup

The Model 702i and 711i supports Ethernet communications for remote data collection, as described in Section 3. In order to establish communications between the PC and the Model 702i or 711i unit, the network information for the Model 702i or 711i must first be configured in the device, then entered into the software's "Hardware Search" utility. Figure 32 shows the *Network Setup* dialogue, with sample values entered. You will need to get the correct values for your own network from your network administrator.



Network Setup	
IP Address	192.168. 1. 1
IP Subnet Mask	255.255.255. 0
IP Def. Gateway	192.168. 1.254

Figure 32 - Network Setup Dialog

Each of the three items (*IP Address*, *IP Subnet Mask*, and *IP Default Gateway*) must be highlighted in turn. By pressing ENTER, you can then edit each digit with the UP and DOWN arrows, and move between digits with the LEFT and RIGHT arrows.

Factory Settings

There is an additional *Factory Settings* menu that is normally only used at the factory. Under special circumstances, including at Beta test sites, this menu may be enabled, but the details of how to use this menu are beyond the scope of this document.